

Guide Pin Bushings (with Collar) Self-Lube Guide Pin Bushings (with Collar) – GDB-ECL

Guide Pin Bushings (with Collar) – GDB-ECS

Bujes guia con collar | Casquilhos | Douilles de guidage (avec épaulement) | Führungsbuchse (mit Bund)

INFORMATION KEY:
D = Inside Diameter
E = Outside Diameter
H = Head Diameter
K = Head Thickness
N = Bushing Length from Head
T = Collar Length
Standard: Euro-Series
Material: 1.7131 (AISI 5115 Type) Steel
Surface Treatment: Case Hardened
Dimensions: Shown in Millimeters (mm)

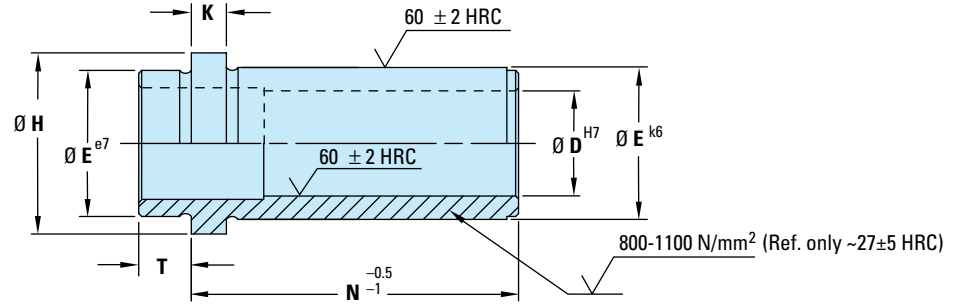

ITEM PREFIX	D	E	H	K	T	N												
						017	022	027	036	046	056	066	076	086	096	116	136	156
GDB-ECS (R04)*	14 OR 15	20	25	6	9		⚡	⚡	⚡	⚡	⚡							
	18 OR 20	26	31	6	9			⚡	⚡	⚡	⚡	⚡						
	22 OR 24	30	35	6	9			⚡	⚡	⚡	⚡	⚡	⚡					
	30 OR 32	42	47	6	9						⚡	⚡	⚡	⚡	⚡			
	40 OR 42	54	60	10	12													

*“(R04)” is only a cross-reference to current D-M-E Europe Catalog item prefix numbers.

HOW TO ORDER: Specify Item Number with prefix, D diameter, and N length. Include zeros and dashes but omit decimals, as shown.

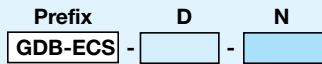

Example:
 Prefix D N
 GDB-ECS-18-036

Example:
 Prefix D N
 GDB-ECS-32-116

KEY TO CHART

- Items in stock
- 2-3 week delivery
- Contact D-M-E for quote

Self-Lube Guide Pin Bushings (with Collar) – GDB-ECL

Bujes guia autolubricados, con collar | Casquilhos auto-lubrificantes con guiamento | Douilles de Guidage autolubrifiantes à collerette | Selbstschmierende Führungsbuchsen (mit Bund)

INFORMATION KEY:
D = Inside Diameter
E = Outside Diameter
H = Head Diameter
K = Head Thickness
N = Bushing Length from Head
T = Collar Length
Standard: Euro-Series
Material: 2.0975 with Graphite Plugs 200HB
Dimensions: Shown in Millimeters (mm)

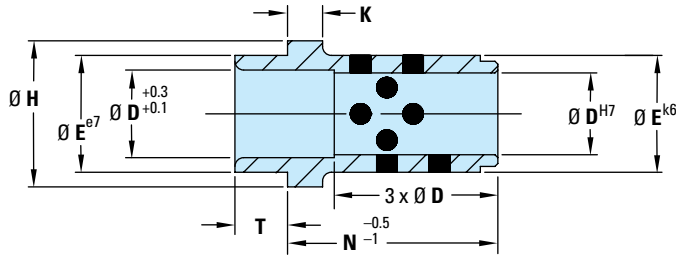

ITEM PREFIX	D	E	H	K	T	N												
						017	022	027	036	046	056	066	076	086	096	116	136	156
GDB-ECL (R04W)*	09 OR 10	14	16	3	3			⚡	⚡									
	14 OR 15	20	25	6	9			⚡	⚡	⚡								
	18 OR 20	26	31	6	9			⚡	⚡	⚡	⚡							
	22 OR 24	30	35	6	9			⚡	⚡	⚡	⚡	⚡						
	30 OR 32	42	47	6	9								⚡	⚡				
	40 OR 42	51	60	10														

*“(R04W)” is only a cross-reference to current D-M-E Europe Catalog item prefix numbers.

HOW TO ORDER: Specify Item Number with prefix, D diameter, and N length. Include zeros and dashes but omit decimals, as shown.

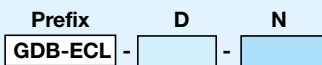

Example:
 Prefix D N
 GDB-ECL-09-036

Example:
 Prefix D N
 GDB-ECL-30-096

KEY TO CHART

- Items in stock
- 2-3 week delivery
- Contact D-M-E for quote

Guide Pin Bushings (without Collar) Self-Lube Guide Pin Bushings (without Collar)

Guide Pins Bushings (without Collar) – GDB-ESS

Bujes guia | Casquilhos | Douilles de guidage (sans épaulement) | Führungsbuchse (ohne Bund)

INFORMATION KEY:
D = Inside Diameter
E = Outside Diameter
H = Head Diameter
K = Head Thickness
L = Bushing Length
Standard: Euro-Series
Material: 1.7131 (AISI 5115 Type) Steel
Surface Treatment: Case Hardened
Dimensions: Shown in Millimeters (mm)

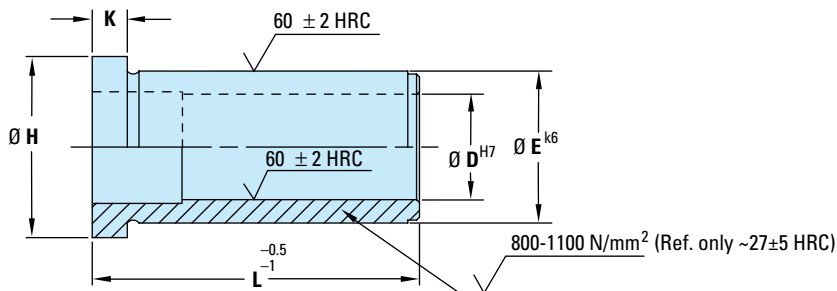

ITEM PREFIX	D	E	H	K	L															
					009	012	017	022	027	036	046	056	066	076	086	096	116	136	156	246
GDB-ESS (R03)*	09 OR 10	14	16	6																
	14 OR 15	20	25	6					⚡	⚡	⚡									
	18 OR 20	26	31	6					⚡	⚡	⚡	⚡		⚡						
	22 OR 24	30	35	6					⚡	⚡	⚡	⚡	⚡	⚡	⚡					
	30 OR 32	42	47	6						⚡				⚡	⚡			⚡		
	40 OR 42	54	60	10																

*“(R03)” is only a cross-reference to current D-M-E Europe Catalog item prefix numbers.

HOW TO ORDER: Specify Item Number with prefix, D diameter, and L length. Include zeros and dashes but omit decimals, as shown.

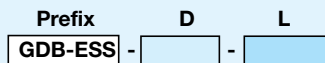

Example:
 Prefix D L
 GDB-ESS-09-022

Example:
 Prefix D L
 GDB-ESS-32-136

KEY TO CHART

- Items in stock
- 2-3 week delivery
- Contact D-M-E for quote

Self-Lube Guide Pin Bushings (without Collar) – GDB-ESL

Bujes guia autolubricados | Casquilhos auto-lubrificantes | Douilles de Guidage autolubrifiantes sans collerette | Selbstschmierende Führungsbuchsen (ohne Bund)

INFORMATION KEY:
D = Inside Diameter
E = Outside Diameter
H = Head Diameter
K = Head Thickness
L = Bushing Length
Standard: Euro-Series
Material: 2.0975 with Graphite Plugs 200HB
Dimensions: Shown in Millimeters (mm)

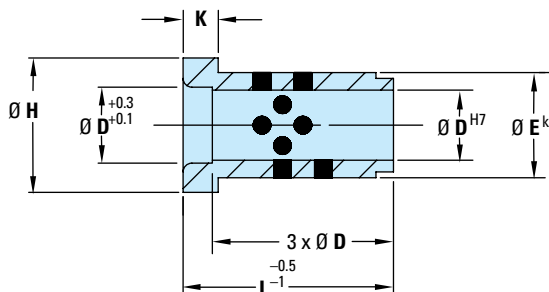

ITEM PREFIX	D	E	H	K	L														
					017	022	027	036	046	056	066	076	086	096	116	136			
GDB-ESL (R03W)*	09 OR 10	14	16	3															
	14 OR 15	20	25	6				⚡	⚡	⚡									
	18 OR 20	26	31	6				⚡	⚡	⚡	⚡								
	22 OR 24	30	35	6				⚡	⚡	⚡	⚡	⚡							
	30 OR 32	42	47	6											⚡	⚡			
	40 OR 42	54	60	10															

*“(R03W)” is only a cross-reference to current D-M-E Europe Catalog item prefix numbers.

HOW TO ORDER: Specify Item Number with prefix, D diameter, and L length. Include zeros and dashes but omit decimals, as shown.



Example:
 Prefix D L
 GDB-ESL-10-036

Example:
 Prefix D L
 GDB-ESL-32-096

KEY TO CHART

- Items in stock
- 2-3 week delivery
- Contact D-M-E for quote